

GSM PHASE 2+ GENERAL PACKET RADIO SERVICE GPRS: ARCHITECTURE, PROTOCOLS, AND AIR INTERFACE

CHRISTIAN BETTSTETTER, HANS-JÖRG VÖGEL, AND JÖRG EBERSPÄCHER
TECHNISCHE UNIVERSITÄT MÜNCHEN (TUM)

ABSTRACT

The General Packet Radio Service (GPRS) is a new bearer service for GSM that greatly improves and simplifies wireless access to packet data networks, e.g., to the Internet. It applies a packet radio principle to transfer user data packets in an efficient way between mobile stations and external packet data networks. This tutorial gives an introduction to GPRS. The article discusses the system architecture and its basic functionality. It explains the offered services, the session and mobility management, the routing, the GPRS air interface including channel coding, and the GPRS protocol architecture. Finally, an interworking example between GPRS and IP networks is shown.

The impressive growth of cellular mobile telephony as well as the number of Internet users promises an exciting potential for a market that combines both innovations: cellular wireless data services. Within the next few years, there will be an extensive demand for wireless data services. In particular, high-performance wireless Internet access will be requested by users.

Existing cellular data services do not fulfill the needs of users and providers. From the user's point of view, data rates are too slow and the connection setup takes too long and is rather complicated. Moreover, the service is too expensive for most users. From the technical point of view, the drawback results from the fact that current wireless data services are based on circuit switched radio transmission. At the air interface, a complete traffic channel is allocated for a single user for the entire call period. In case of bursty traffic (e.g., Internet traffic), this results in a highly inefficient resource utilization. It is obvious that for bursty traffic, packet switched bearer services result in a much better utilization of the traffic channels. This is because a channel will only be allocated when needed and will be released immediately after the transmission of the packets. With this principle, multiple users can share one physical channel (statistical multiplexing).

In order to address these inefficiencies, two cellular packet data technologies have been developed so far: cellular digital packet data (CDPD) (for AMPS, IS-95, and IS-136) and the General Packet Radio Service (GPRS). GPRS is the topic of this paper. It was originally developed for GSM, but will also

be integrated within IS-136 (see [1]). We treat GPRS from the point of view of GSM.

GPRS is a new bearer service for GSM that greatly improves and simplifies wireless access to packet data networks, e.g., to the Internet. It applies a packet radio principle to transfer user data packets in an efficient way between GSM mobile stations and external packet data networks. Packets can be directly routed from the GPRS mobile stations to packet switched networks. Networks based on the Internet Protocol (IP) (e.g., the global Internet or private/corporate intranets) and X.25 networks are supported in the current version of GPRS.

Users of GPRS benefit from shorter access times and higher data rates. In conventional GSM, the connection setup takes several seconds and rates for data transmission are restricted to 9.6 kbit/s. GPRS in practice offers session establishment times below one second and ISDN-like data rates up to several ten kbit/s.

In addition, GPRS packet transmission offers a more user-friendly billing than that offered by circuit switched services. In circuit switched services, billing is based on the duration of the connection. This is unsuitable for applications with bursty traffic. The user must pay for the entire airtime, even for idle periods when no packets are sent (e.g., when the user reads a Web page). In contrast to this, with packet switched services, billing can be based on the amount of transmitted data. The advantage for the user is that he or she can be "online" over a long period of time but will be billed based on the transmitted data volume.

To sum up, GPRS improves the utilization of the radio resources, offers volume-based billing, higher transfer rates, shorter access times, and simplifies the access to packet data networks.

GPRS has been standardized by ETSI (the European Telecommunications Standards Institute) during the last five years. It finds great interest among many GSM network providers. At the moment field trials are being carried out, and it is expected that GPRS will be implemented in various countries by the middle of 2000 (see, e.g., [2][3] for Germany).

This article provides an introduction to GPRS. We assume that the reader is familiar with the basic concepts of cellular networks. A brief overview of the GSM system can be found in [4]. In addition, there exists a variety of books on GSM, e.g., [5][6][7]. The structure of the paper is as follows. First we describe the GPRS system architecture and discuss the fundamental functionality. We then describe the offered services and the Quality of Service parameters. Afterward we show how a GPRS mobile station registers with the network, and how the network keeps track of its location. An example of how packets are routed in GPRS is given. Next, the physical layer at the air interface is explained, and we discuss the concept of multiple access, radio resource management, and the logical channels and their mapping onto physical channels. We then consider GPRS channel coding, and follow this with a discussion of the GPRS protocol architecture. Finally, we give an example of a GPRS-Internet interconnection.

SYSTEM ARCHITECTURE

GENERAL GSM CONCEPT

In order to understand the GPRS system architecture, let us review the general GSM system concept and GSM addressing [5].

GSM System Architecture – Fig. 1 shows the system architecture of a GSM public land mobile network (PLMN) with essential components [5]. A GSM mobile station is denoted as MS. A cell is formed by the radio area coverage of a base transceiver station (BTS). Several BTSs together are controlled by one base station controller (BSC). The BTS and BSC together form the base station subsystem (BSS). The combined traffic of the mobile stations in their respective cells is routed through a switch, the mobile switching center (MSC). Connections originating from or terminating in the fixed network (e.g., ISDN) are handled by a dedicated gateway mobile switching center (GMSC). GSM networks are structured hierarchically. They consist of at least one administrative region, which is assigned to a MSC. Each administrative region is made up of at least one location area (LA). A location area consists of several cell groups. Each cell group is assigned to a BSC.

Several data bases are available for call control and network management: the home location register (HLR), the visited location register (VLR), the authentication center (AUC), and the equipment identity register (EIR).

For all users registered with a network operator, permanent data (such as the user's profile) as well as temporary data

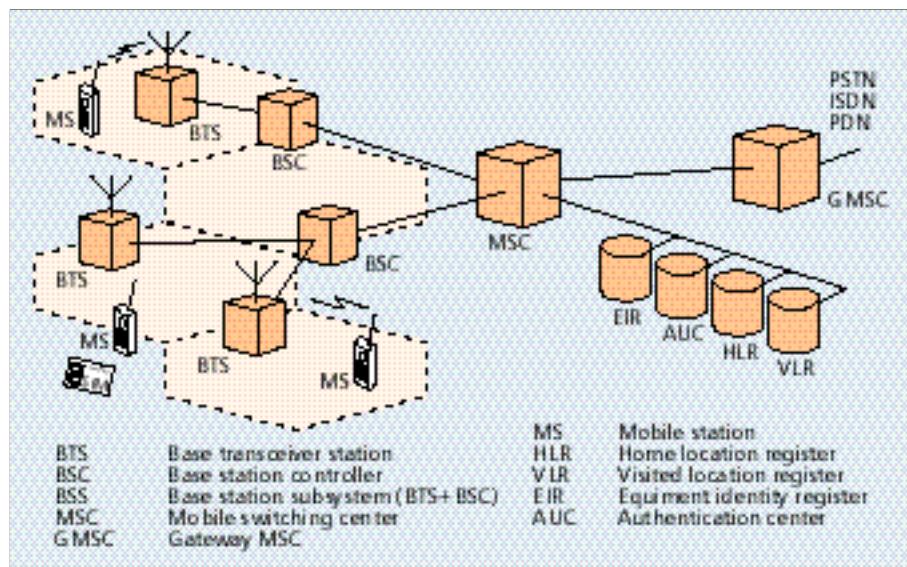

■ FIGURE 1. GSM system architecture with essential components.

(such as the user's current location) are stored in the HLR. In case of a call to a user, the HLR is always first queried, to determine the user's current location. A VLR is responsible for a group of location areas and stores the data of those users who are currently in its area of responsibility. This includes parts of the permanent user data that have been transmitted from the HLR to the VLR for faster access. But the VLR may also assign and store local data such as a temporary identification. The AUC generates and stores security-related data such as keys used for authentication and encryption, whereas the EIR registers equipment data rather than subscriber data.

GSM Addresses and Identifiers – GSM distinguishes explicitly between user and equipment and deals with them separately. Besides phone numbers and subscriber and equipment identifiers, several other identifiers have been defined; they are needed for the management of subscriber mobility and for addressing of all the remaining network elements.

The international mobile station equipment identity (IMEI) uniquely identifies a mobile station internationally. It is a kind of serial number. The IMEI is allocated by the equipment manufacturer and registered by the network operator who stores it in the EIR.

Each registered user is uniquely identified by its international mobile subscriber identity (IMSI). It is stored in the subscriber identity module (SIM) (see Fig. 1). A mobile station can only be operated if a SIM with a valid IMSI is inserted into equipment with a valid IMEI.

The "real telephone number" of a mobile station is the mobile subscriber ISDN number (MSISDN). It is assigned to the subscriber (his or her SIM, respectively), such that a mobile station set can have several MSISDNs depending on the SIM.

The VLR, which is responsible for the current location of a subscriber, can assign a temporary mobile subscriber identity (TMSI) which has only local significance in the area handled by the VLR. It is stored on the network side only in the VLR and is not passed to the HLR.

GPRS SYSTEM ARCHITECTURE

In order to integrate GPRS into the existing GSM architecture, a new class of network nodes, called GPRS support nodes (GSN), has been introduced [8]. GSNs are responsible for the delivery and routing of data packets between the

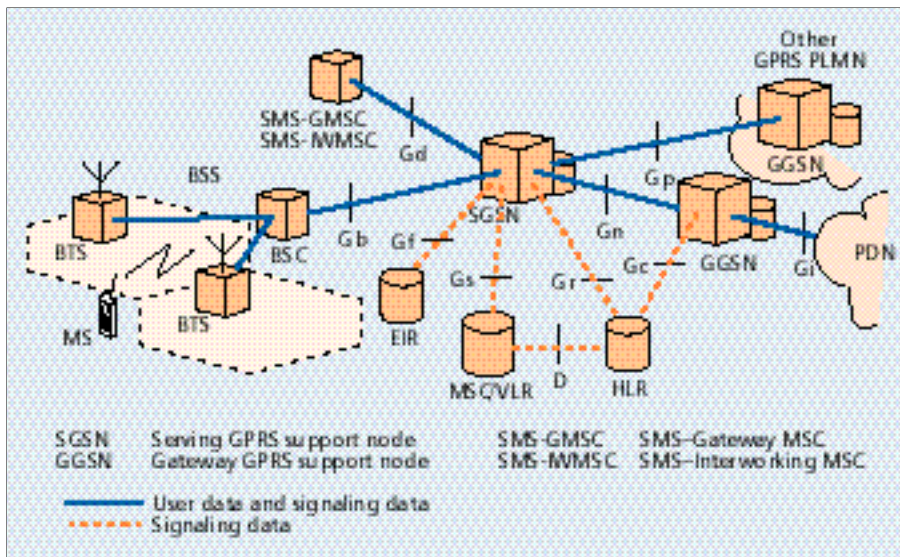

■ FIGURE 2. GPRS system architecture.

mobile stations and the external packet data networks (PDN). Fig. 2 illustrates the system architecture.

A serving GPRS support node (SGSN) is responsible for the delivery of data packets from and to the mobile stations within its service area. Its tasks include packet routing and transfer, mobility management (attach/detach and location management), logical link management, and authentication and charging functions. The location register of the SGSN stores location information (e.g., current cell, current VLR) and user profiles (e.g., IMSI, address(es) used in the packet data network) of all GPRS users registered with this SGSN.

A gateway GPRS support node (GGSN) acts as an interface between the GPRS backbone network and the external

packet data networks. It converts the GPRS packets coming from the SGSN into the appropriate packet data protocol (PDP) format (e.g., IP or X.25) and sends them out on the corresponding packet data network. In the other direction, PDP addresses of incoming data packets are converted to the GSM address of the destination user. The readdressed packets are sent to the responsible SGSN. For this purpose, the GGSN stores the current SGSN address of the user and his or her profile in its location register. The GGSN also performs authentication and charging functions.

In general, there is a many-to-many relationship between the SGSNs and the GGSNs: A GGSN is the interface to external packet data networks for several SGSNs; an

SGSN may route its packets over different GGSNs to reach different packet data networks.

Fig. 2 also shows the interfaces between the new network nodes and the GSM network as defined by ETSI in [8].

The Gb interface connects the BSC with the SGSN. Via the Gn and the Gp interfaces, user data and signaling data are transmitted between the GSNs. The Gn interface will be used if SGSN and GGSN are located in the same PLMN, whereas the Gp interface will be used if they are in different PLMNs.

All GSNs are connected via an IP-based GPRS backbone network. Within this backbone, the GSNs encapsulate the PDN packets and transmit (tunnel) them using the GPRS Tunneling Protocol GTP. There are two kinds of GPRS backbones:

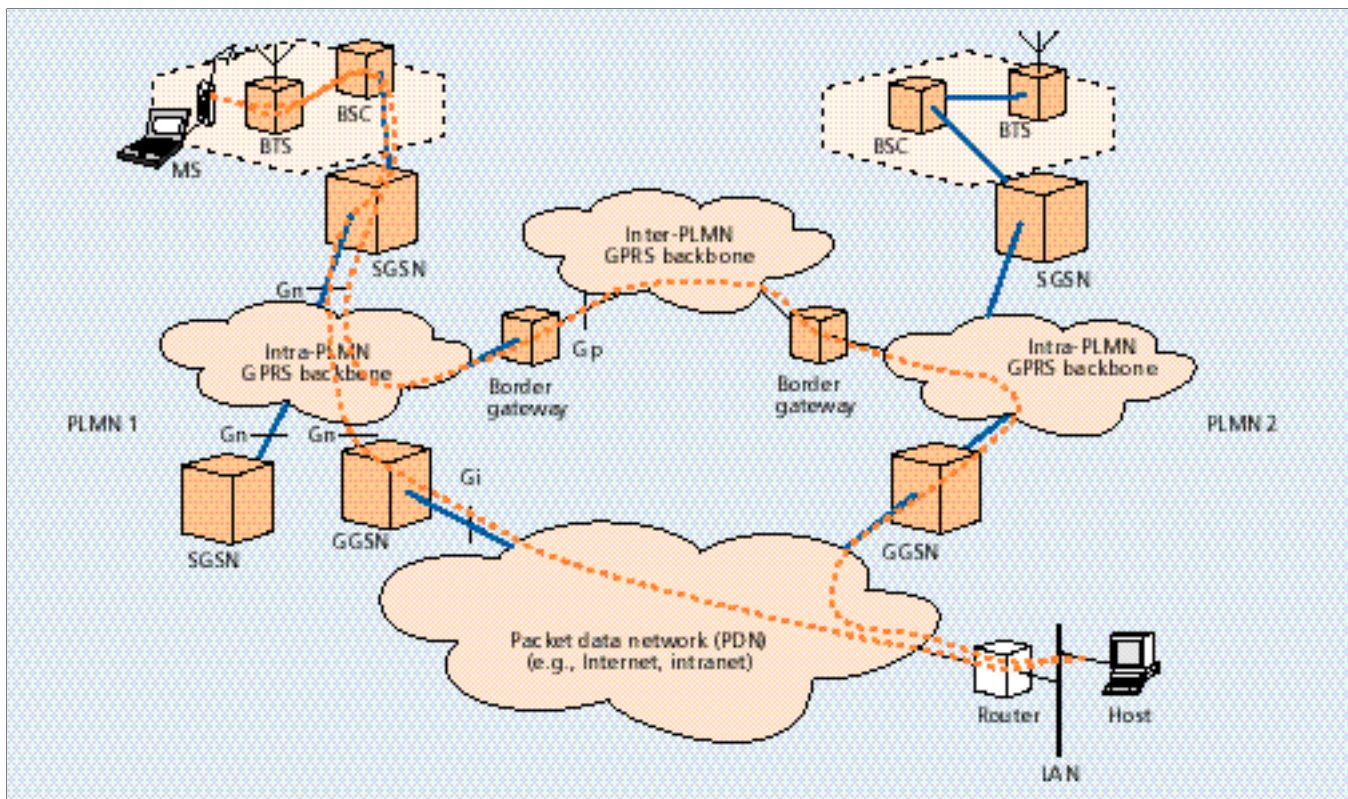

■ FIGURE 3. GPRS system architecture and routing example.

- Intra-PLMN backbone networks connect GSNs of the same PLMN and are therefore private IP-based networks of the GPRS network provider.
- Inter-PLMN backbone networks connect GSNs of different PLMNs. A roaming agreement between two GPRS network providers is necessary to install such a backbone.

Fig. 3 shows two intra-PLMN backbone networks of different PLMNs connected with an inter-PLMN backbone. The gateways between the PLMNs and the external inter-PLMN backbone are called border gateways. Among other things, they perform security functions to protect the private intra-PLMN backbones against unauthorized users and attacks. The illustrated routing example will be explained later.

The Gn and Gp interfaces are also defined between two SGSNs. This allows the SGSNs to exchange user profiles when a mobile station moves from one SGSN area to another.

Across the Gf interface, the SGSN may query the IMEI of a mobile station trying to register with the network.

The Gi interface connects the PLMN with external public or private PDNs, such as the Internet or corporate intranets. Interfaces to IP (IPv4 and IPv6) and X.25 networks are supported.

The HLR stores the user profile, the current SGSN address, and the PDP address(es) for each GPRS user in the PLMN. The Gr interface is used to exchange this information between HLR and SGSN. For example, the SGSN informs the HLR about the current location of the MS. When the MS registers with a new SGSN, the HLR will send the user profile to the new SGSN. The signaling path between GGSN and HLR (Gc interface) may be used by the GGSN to query a user's location and profile in order to update its location register.

In addition, the MSC/VLR may be extended with functions and register entries that allow efficient coordination between packet switched (GPRS) and circuit switched (conventional GSM) services. Examples of this are combined GPRS and non-GPRS location updates and combined attachment procedures. Moreover, paging requests of circuit switched GSM calls can be performed via the SGSN. For this purpose, the Gs interface connects the data bases of SGSN and MSC/VLR.

To exchange messages of the short message service (SMS) via GPRS, the Gd interface is defined. It interconnects the SMS gateway MSC (SMS-GMSC) with the SGSN.

SERVICES

BEARER SERVICES AND SUPPLEMENTARY SERVICES

The bearer services of GPRS offer end-to-end packet switched data transfer. There are two different kinds: The point-to-point (PTP) service and the point-to-multipoint (PTM) service. The latter will be available in future releases of GPRS.

The PTP service [9] offers transfer of data packets between two users. It is offered in both connectionless mode (PTP connectionless network service (PTP-CLNS), e.g., for IP) and connection-oriented mode (PTP connection-oriented network service (PTP-CONS), e.g., for X.25).

The PTM service offers transfer of data packets from one user to multiple users. There exist two kinds of PTM services [10]:

- Using the multicast service PTM-M, data packets are broadcast in a certain geographical area. A group identifier indicates whether the packets are intended for all users or for a group of users.
- Using the group call service PTM-G, data packets are addressed to a group of users (PTM group) and are sent out in geographical areas where the group members are currently located.

Class	Probability for			
	Lost packet	Duplicated packet	Out of sequence packet	Corrupted packet
1	10^{-9}	10^{-9}	10^{-9}	10^{-9}
2	10^{-4}	10^{-5}	10^{-5}	10^{-6}
3	10^{-2}	10^{-5}	10^{-5}	10^{-2}

■ Table 1. Reliability classes.

Class	128 byte packet		1024 byte packet	
	Mean delay	95% delay	Mean delay	95% delay
1	<0.5s	<1.5s	<2s	<7s
2	<5s	<25s	<15s	<75s
3	<50s	<250s	<75s	<375s
4	Best effort	Best effort	Best effort	Best effort

■ Table 2. Delay classes.

It is also possible to send SMS messages over GPRS. In addition, it is planned to implement supplementary services, such as call forwarding unconditional (CFU), call forwarding on mobile subscriber not reachable (CFNRc), and closed user group (CUG).

Moreover, a GPRS service provider may offer additional non-standardized services, such as access to data bases, messaging services, and tele-action services (e.g., credit card validations, lottery transactions, and electronic monitoring and surveillance systems) [9].

QUALITY OF SERVICE

The Quality of Service QoS requirements of typical mobile packet data applications are very diverse (e.g., consider real-time multimedia, Web browsing, and e-mail transfer). Support of different QoS classes, which can be specified for each individual session, is therefore an important feature. GPRS allows defining QoS profiles using the parameters service precedence, reliability, delay, and throughput [9].

- The service precedence is the priority of a service in relation to another service. There exist three levels of priority: high, normal, and low.
- The reliability indicates the transmission characteristics required by an application. Three reliability classes are defined, which guarantee certain maximum values for the probability of loss, duplication, mis-sequencing, and corruption (an undetected error) of packets (see Table 1).
- The delay parameters define maximum values for the mean delay and the 95-percentile delay (see Table 2). The latter is the maximum delay guaranteed in 95 percent of all transfers. The delay is defined as the end-to-end transfer time between two communicating mobile stations or between a mobile station and the Gi interface to an external packet data network. This includes all delays within the GPRS network, e.g., the delay for request and assignment of radio resources and the transit delay in the GPRS backbone network. Transfer delays outside the GPRS network, e.g., in external transit networks, are not taken into account.

- The throughput specifies the maximum/peak bit rate and the mean bit rate.
- Using these QoS classes, QoS profiles can be negotiated between the mobile user and the network for each session, depending on the QoS demand and the current available resources. The billing of the service is then based on the transmitted data volume, the type of service, and the chosen QoS profile.

SIMULTANEOUS USAGE OF PACKET SWITCHED AND CIRCUIT SWITCHED SERVICES

In a GSM/GPRS network, conventional circuit switched services (speech, data, and SMS) and GPRS services can be used in parallel. Three classes of mobile stations are defined [9]:

- A class A mobile station supports simultaneous operation of GPRS and conventional GSM services.
- A class B mobile station is able to register with the network for both GPRS and conventional GSM services simultaneously. In contrast to an MS of class A, it can only use one of the two services at a given time.
- A class C mobile station can attach for either GPRS or conventional GSM services. Simultaneous registration (and usage) is not possible. An exception are SMS messages, which can be received and sent at any time.

SESSION MANAGEMENT, MOBILITY MANAGEMENT, AND ROUTING

In this section, we describe how a mobile station (MS) registers with the GPRS network and becomes known to an external packet data network (PDN). We show how packets are routed to or from mobile stations, and how the network keeps track of the current location of the user.

ATTACHMENT AND DETACHMENT PROCEDURE

Before a mobile station can use GPRS services, it must register with an SGSN of the GPRS network. The network checks if the user is authorized, copies the user profile from the HLR to the SGSN, and assigns a packet temporary mobile subscriber identity (P-TMSI) to the user. This procedure is called GPRS attach. For mobile stations using both circuit switched

and packet switched services it is possible to perform combined GPRS/IMSI attach procedures. The disconnection from the GPRS network is called GPRS detach. It can be initiated by the mobile station or by the network (SGSN or HLR).

SESSION MANAGEMENT, PDP CONTEXT

To exchange data packets with external PDNs after a successful GPRS attach, a mobile station must apply for one or more addresses used in the PDN, e.g., for an IP address in case the PDN is an IP network. This address is called PDP address (Packet Data Protocol address). For each session, a so-called PDP context is created, which describes the characteristics of the session. It contains the PDP type (e.g., IPv4), the PDP address assigned to the mobile station (e.g., 129.187.222.10), the requested QoS, and the address of a GGSN that serves as the access point to the PDN. This context is stored in the MS, the SGSN, and the GGSN. With an active PDP context, the mobile station is “visible” for the external PDN and is able to send and receive data packets. The mapping between the two addresses, PDP and IMSI, enables the GGSN to transfer data packets between PDN and MS. A user may have several simultaneous PDP contexts active at a given time.

The allocation of the PDP address can be static or dynamic. In the first case, the network operator of the user’s home-PLMN permanently assigns a PDP address to the user. In the second case, a PDP address is assigned to the user upon activation of a PDP context. The PDP address can be assigned by the operator of the user’s home-PLMN (dynamic home-PLMN PDP address) or by the operator of the visited network (dynamic visited-PLMN PDP address). The home network operator decides which of the possible alternatives may be used. In case of dynamic PDP address assignment, the GGSN is responsible for the allocation and the activation/deactivation of the PDP addresses.

Fig. 4 shows the PDP context activation procedure. Using the message “activate PDP context request,” the MS informs the SGSN about the requested PDP context. If dynamic PDP address assignment is requested, the parameter PDP address will be left empty. Afterward, usual security functions (e.g., authentication of the user) are performed. If access is granted, the SGSN will send a “create PDP context request” message to the affected GGSN. The latter creates a new entry in its PDP context table, which enables the GGSN to route data packets between the SGSN and the external PDN. Afterward, the GGSN returns a confirmation message “create PDP context response” to the SGSN, which contains the PDP address in case dynamic PDP address allocation was requested. The SGSN updates its PDP context table and confirms the activation of the new PDP context to the MS (“activate PDP context accept”).

GPRS also supports anonymous PDP context activation. In this case, security functions as shown in Fig. 4 are skipped, and thus, the user (i.e., the IMSI) using the PDP context remains unknown to the network. Anonymous context activation may be employed for pre-paid services, where the user does not want to be identified. Only dynamic address allocation is possible in this case.

ROUTING

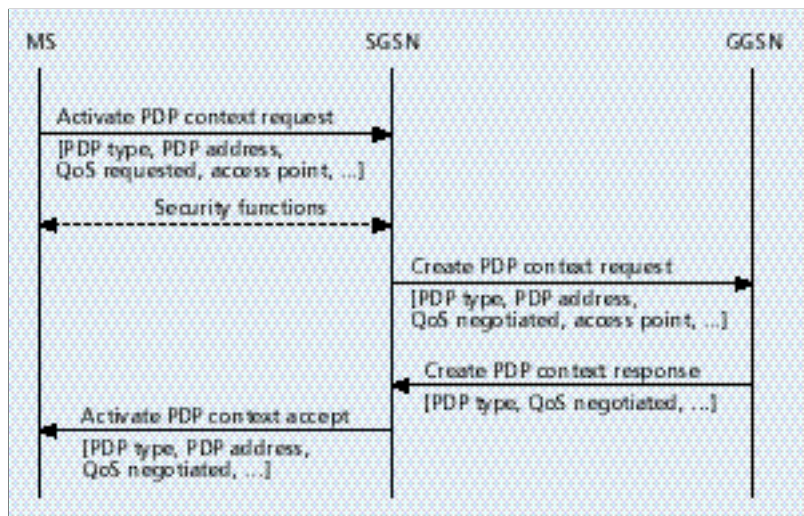

FIGURE 4. PDP context activation.

Fig. 3 gives an example of how packets are

routed in GPRS. We assume that the packet data network is an IP network. A GPRS mobile station located in PLMN1 sends IP packets to a host connected to the IP network, e.g., to a Web server connected to the Internet. The SGSN that the mobile station is registered with encapsulates the IP packets coming from the mobile station, examines the PDP context, and routes them through the intra-PLMN GPRS backbone to the appropriate GGSN. The GGSN decapsulates the packets and sends them out on the IP network, where IP routing mechanisms are used to transfer the packets to the access router of the destination network. The latter delivers the IP packets to the host.

Let us assume the home-PLMN of the mobile station is PLMN2. An IP address has been assigned to the mobile by the GGSN of PLMN2. Thus, the MS's IP address has the same network prefix as the IP address of the GGSN in PLMN2. The correspondent host is now sending IP packets to the MS. The packets are sent out onto the IP network and are routed to the GGSN of PLMN2 (the home-GGSN of the MS). The latter queries the HLR and obtains the information that the MS is currently located in PLMN1. It encapsulates the incoming IP packets and tunnels them through the inter-PLMN GPRS backbone to the appropriate SGSN in PLMN1. The SGSN decapsulates the packets and delivers them to the MS.

LOCATION MANAGEMENT

The main task of location management is to keep track of the user's current location, so that incoming packets can be routed to his or her MS. For this purpose, the MS frequently sends location update messages to its current SGSN. If the MS sends updates rather seldom, its location (e.g., its current cell) is not known exactly and paging is necessary for each downlink packet, resulting in a significant delivery delay. On the other hand, if location updates happen very often, the MS's location is well known to the network, and the data packets can be delivered without any additional paging delay. However, quite a lot of uplink radio capacity and battery power is consumed for mobility management in this case. Thus, a good location management strategy must be a compromise between these two extreme methods.

For this reason, a state model shown in Fig. 5 has been defined for location management in GPRS [11]. A MS can be in one of three states depending on its current traffic amount; the location update frequency is dependent on the state of the MS.

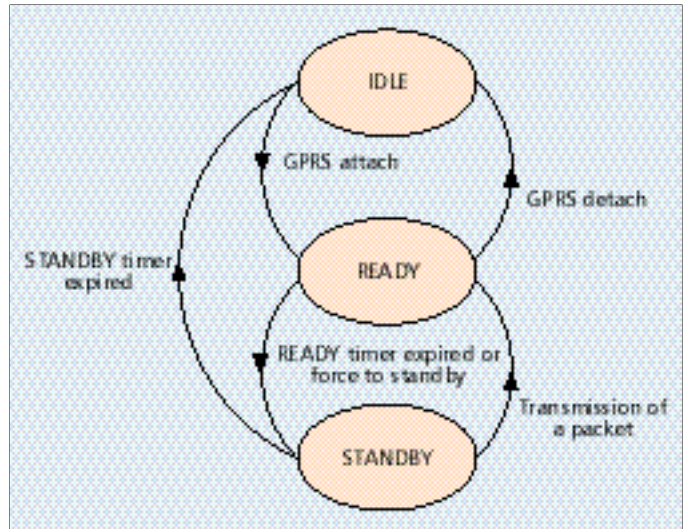

■ FIGURE 5. State model of a GPRS mobile station.

In IDLE state the MS is not reachable. Performing a GPRS attach, the MS gets into READY state. With a GPRS detach it may disconnect from the network and fall back to IDLE state. All PDP contexts will be deleted. The STANDBY state will be reached when an MS does not send any packets for a longer period of time, and therefore the READY timer (which was started at GPRS attach) expires.

In IDLE state, no location updating is performed, i.e., the current location of the MS is unknown to the network. An MS in READY state informs its SGSN of every movement to a new cell. For the location management of an MS in STANDBY state, a GSM location area (LA) is divided into several routing areas (RA). In general, an RA consists of several cells. The SGSN will only be informed when an MS moves to a new RA; cell changes will not be disclosed. To find out the current cell of an MS in STANDBY state, paging of the MS within a certain RA must be performed (see Fig. 9). For MSs in READY state, no paging is necessary.

Whenever an MS moves to a new RA, it sends a "routing area update request" to its assigned SGSN (see Fig. 6). The message contains the routing area identity (RAI) of its old RA. The base station subsystem (BSS) adds the cell identifier (CI) of the new cell, from which the SGSN can derive the new RAI. Two different scenarios are possible:

- Intra-SGSN routing area update (Fig. 6): The MS has moved to an RA that is assigned to the same SGSN as the old RA. In this case, the SGSN has already stored the necessary user profile and can assign a new packet temporary mobile subscriber identity (P-TMSI) to the user ("routing area update accept"). Since the routing context does not change, there is no need to inform other network elements, such as GGSN or HLR.

- Inter-SGSN routing area update: The new RA is administered by a different SGSN than the old RA. The new SGSN realizes that the MS has changed to its area and requests the old SGSN to send the PDP contexts of the user. Afterward, the new SGSN informs the involved GGSNs about the user's new routing context. In addition, the HLR and (if needed) the MSC/VLR are informed about the user's new SGSN.

There also exist combined RA/LA updates. These occur when an MS using

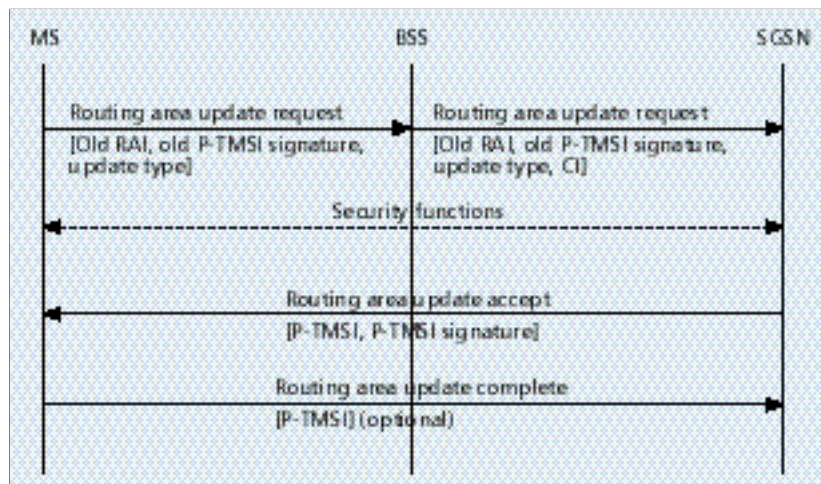

■ FIGURE 6. Intra-SGSN routing area update.

GPRS as well as conventional GSM moves to a new LA. The MS sends a "routing area update request" to the SGSN. The parameter "update type" is used to indicate that an LA update is needed. The message is then forwarded to the VLR, which performs the LA update.

To sum up, GPRS mobility management consists of two levels: Micro mobility management tracks the current routing area or cell of the mobile station. It is performed by the SGSN. Macro mobility management keeps track of the mobile station's current SGSN and stores it in the HLR, VLR, and SGSN.

AIR INTERFACE – PHYSICAL LAYER

MULTIPLE ACCESS AND RADIO RESOURCE MANAGEMENT PRINCIPLES

On the physical layer, GSM uses a combination of FDMA and TDMA for multiple access. As shown in Fig. 7, two frequency bands 45 MHz apart have been reserved for GSM operation: 890 – 915 MHz for transmission from the mobile station, i.e., uplink, and 935 – 960 MHz for transmission from the BTS, i.e., downlink. Each of these bands of 25 MHz width is divided into 124 single carrier channels of 200 kHz width. A certain number of these frequency channels, the so-called cell allocation, is allocated to a BTS, i.e., to a cell [5].

Each of the 200 kHz frequency channels carries eight TDMA channels by dividing each of them into eight time slots. The eight time slots in these TDMA channels form a TDMA frame. Each time slot of a TDMA frame lasts for a duration of 156.25 bit times and, if used, contains a data burst. The time slot lasts $15/26 \text{ ms} = 576.9 \mu\text{s}$; so a frame

takes 4.613 ms. The recurrence of one particular time slot defines a physical channel. A GSM mobile station uses the same time slots in the uplink as in the downlink [5].

The channel allocation in GPRS is different from the original GSM. GPRS allows a single mobile station to transmit on multiple time slots of the same TDMA frame (multislot operation). This results in a very flexible channel allocation: one to eight time slots per TDMA frame can be allocated for one mobile station. Moreover, uplink and downlink are allocated separately, which efficiently supports asymmetric data traffic (e.g., Web browsing).

In conventional GSM, a channel is permanently allocated for a particular user during the entire call period (whether data is transmitted or not). In contrast to this, in GPRS the channels are only allocated when data packets are sent or received, and they are released after the transmission. For bursty traffic this results in a much more efficient usage of the scarce radio resources. With this principle, multiple users can share one physical channel.

A cell supporting GPRS may allocate physical channels for GPRS traffic. Such a physical channel is denoted as packet data channel (PDCH). The PDCHs are taken from the common pool of all channels available in the cell. Thus, the radio resources of a cell are shared by all GPRS and non-GPRS mobile stations located in this cell. The mapping of physical channels to either packet switched (GPRS) or circuit switched (conventional GSM) services can be performed dynamically (capacity on demand principle [12]), depending on the current traffic load, the priority of the service, and the multislot class. A load supervision procedure monitors the load of the PDCHs in the cell. According to the current demand, the number of channels allocated for GPRS (i.e., the number of PDCHs) can

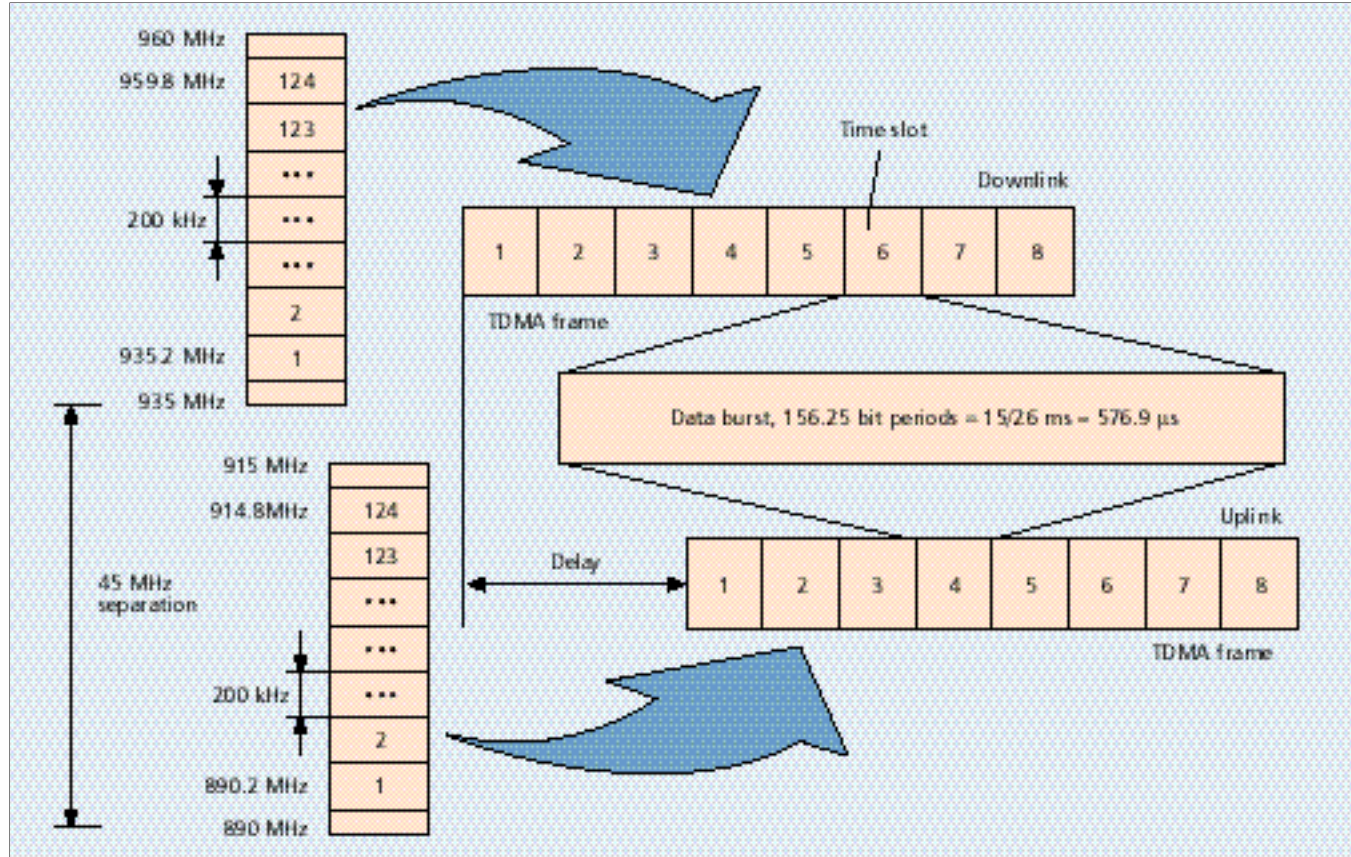

■ FIGURE 7. GSM carrier frequencies, duplexing, and TDMA frames.

be changed. Physical channels not currently in use by conventional GSM can be allocated as PDCHs to increase the quality of service for GPRS. When there is a resource demand for services with higher priority, PDCHs can be de-allocated.

LOGICAL CHANNELS IN GPRS

On top of the physical channels, a series of logical channels are defined to perform a multiplicity of functions, e.g., signaling, broadcast of general system information, synchronization, channel assignment, paging, or payload transport.

Table 3 lists the packet data logical channels defined in GPRS [12]. As with conventional GSM, they can be divided into two categories: traffic channels and signaling (control) channels.

The packet data traffic channel (PDTCH) is employed for the transfer of user data. It is assigned to one mobile station (or in the case of PTM to multiple mobile stations). One mobile station can use several PDTCHs simultaneously.

The packet broadcast control channel (PBCCH) is a unidirectional point-to-multipoint signaling channel from the base station subsystem (BSS) to the mobile stations. It is used by the BSS to broadcast specific information about the organization of the GPRS radio network to all GPRS mobile stations of a cell. Besides system information about GPRS, the PBCCH should also broadcast important system information about circuit switched services, so that a GSM/GPRS mobile station does not need to listen to the broadcast control channel (BCCH).

The packet common control channel (PCCCH) is a bidirectional point-to-multipoint signaling channel that transports signaling information for network access management, e.g., for allocation of radio resources and paging. It consists of four sub-channels:

- The packet random access channel (PRACH) is used by the mobile to request one or more PDTCH.
- The packet access grant channel (PAGCH) is used to allocate one or more PDTCH to a mobile station.
- The packet paging channel (PPCH) is used by the BSS to find out the location of a mobile station (paging) prior to downlink packet transmission.
- The packet notification channel (PNCH) is used to inform a mobile station of incoming PTM messages (multicast or group call).

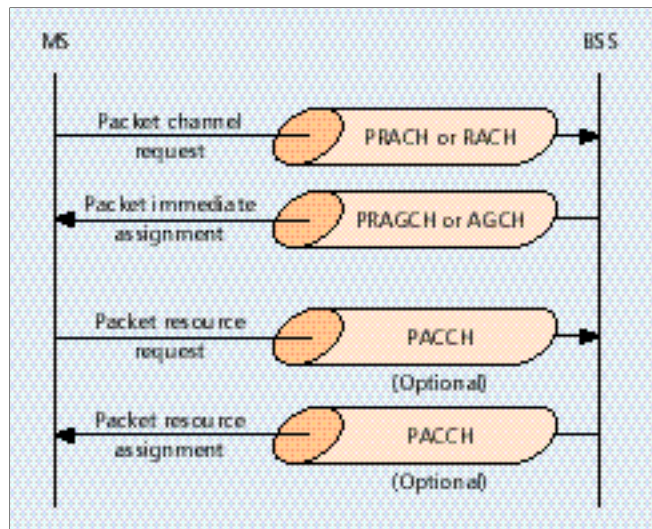

■ FIGURE 8. Uplink channel allocation (mobile originated packet transfer); one or two steps.

Group	Channel	Function	Direction
Packet data traffic channel	PDTCH	Data traffic	MS BSS
Packet broadcast control channel	PBCCH	Broadcast control	MS BSS
Packet common control channel (PCCCH)	PRACH	Random access	MS BSS
	PAGCH	Access grant	MS BSS
	PPCH	Paging	MS BSS
	PNCH	Notification	MS BSS
Packet dedicated control channels	PACCH	Associated control	MS BSS
	PTCCH	Timing advance control	MS BSS

■ Table 3. Logical channels in GPRS.

The dedicated control channel is a bidirectional point-to-point signaling channel. It contains the channels PACCH and PTCCH:

- The packet associated control channel (PACCH) is always allocated in combination with one or more PDTCH that are assigned to one mobile station. It transports signaling information related to one specific mobile station (e.g., power control information).
- The packet timing advance control channel (PTCCH) is used for adaptive frame synchronization.

The coordination between circuit switched and packet switched logical channels is important. If the PCCCH is not available in a cell, a mobile station can use the common control channel (CCCH) of conventional GSM to initiate the packet transfer. Moreover, if the PBCCH is not available, it will listen to the broadcast control channel (BCCH) to get informed about the radio network.

Fig. 8 shows the principle of the uplink channel allocation (mobile originated packet transfer) [12]. A mobile station requests radio resources for uplink transfer by sending a “packet channel request” on the PRACH or RACH. The network answers on the PAGCH or AGCH, respectively. It tells the mobile station which PDCHs it may use. A so-called uplink state flag (USF) is transmitted in the downlink to tell the mobile station whether or not the uplink channel is free. Fig. 9 illustrates the paging procedure of a mobile station (mobile terminated packet transfer) [12].

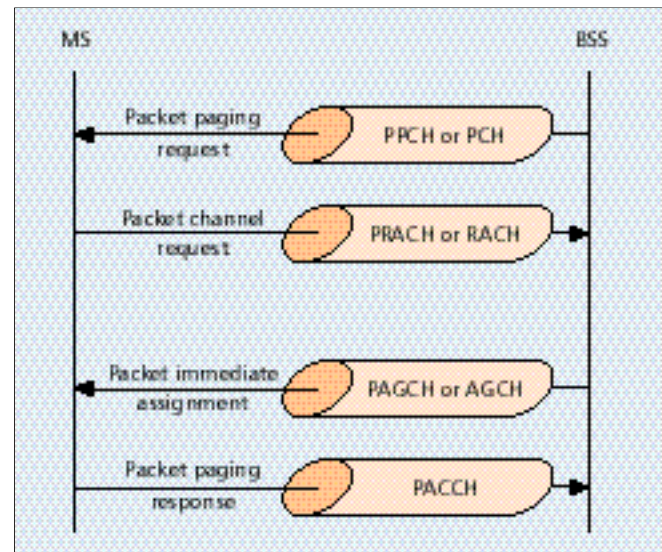

■ FIGURE 9. Paging (mobile terminated packet transfer).

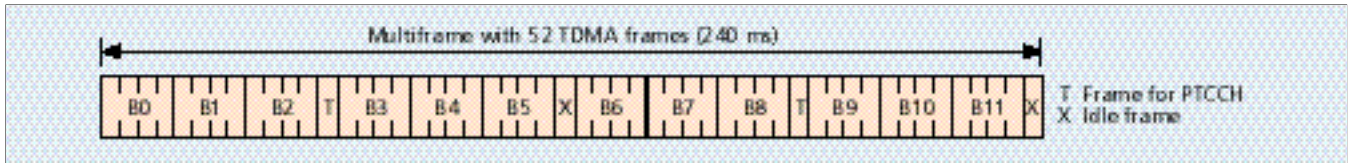

■ FIGURE 10. Multiframe structure with 52 frames.

Coding scheme	Pre-cod. USF	Infobits without USF	Parity bits BC	Tail bits	Output conv encoder	Punctured bits	Code rate	Data rate kbits/s
CS-1	3	181	40	4	456	0	1/2	9.05
CS-2	6	268	16	4	588	132	~2/3	13.4
CS-3	6	312	16	4	676	220	~3/4	15.6
CS-4	12	428	16	-	456	-	1	21.4

■ Table 4. Channel coding schemes for the logical traffic channels in GPRS.

MAPPING OF PACKET DATA LOGICAL CHANNELS ONTO PHYSICAL CHANNELS

The mapping of logical channels onto physical channels has two components: mapping in frequency and mapping in time. The mapping in frequency is based on the TDMA frame number and the frequencies allocated to the BTS and the mobile station. The mapping in time is based on the definition of complex multiframe structures on top of the TDMA frames. A multiframe structure for PDCHs consisting of 52 TDMA frames is shown in Fig. 10 [13]. Four consecutive TDMA frames form one block (12 blocks, B0–11), two TDMA frames are reserved for transmission of the PTCCH, and the remaining two frames are idle frames.

The mapping of the logical channels onto the blocks B0 – B11 of the multiframe can vary from block to block and is controlled by parameters that are broadcast on the PBCCH. In [13], it is defined which time slots may be used by a logical channel.

Besides the 52-multiframe, which can be used by all logical GPRS channels, a 51-multiframe structure is defined. It is used for PDCHs carrying only the logical channels PCCCH and PBCCH and no other logical channels.

CHANNEL CODING

Channel coding is used to protect the transmitted data packets against errors. The channel coding technique in GPRS is quite similar to the one employed in conventional GSM. An outer block coding, an inner convolutional coding, and an interleaving scheme is used.

Four different coding schemes are defined [14]. Their parameters are listed in Table 4. Let us use coding scheme CS-2 to discuss the encoding process illustrated in Fig. 11.

First of all, 271 information bits (including the 3-bit uplink state flag (USF)) are mapped to 287 bits using a systematic block encoder, i.e., 16 parity bits are added. The USF pre-encoding maps the first three bits of the information block (i.e., the USF) to six bits in a systematic way. Afterward, four zero bits (tail bits) are added at the end of the entire block. The tail bits are needed for termination of the subsequent convolutional coding. For the convolutional coding, a non-systematic rate-1/2 encoder with constraint length 4 is used. It is defined by the generator polynomials

$$g^{(1)}(D) = 1 + D^3 + D^4$$

$$g^{(2)}(D) = 1 + D + D^3 + D^4,$$

where D denotes the delay operator [15].

A possible encoder realization is shown in Fig. 12. At the output of the convolutional encoder a codeword $v(D) = (v^{(0)}(D), v^{(1)}(D))$ of length 588 bits results. The output sequences of bits are defined by $v^{(1)}(D) = u(D) g^{(1)}(D)$ and $v^{(2)}(D) = u(D) g^{(2)}(D)$. After the encoding, 132 bits are punctured, resulting in a codeword of length 456 bits. Thus, we obtain a code rate of the convolutional encoder (including the puncturing) of

$$R = \frac{271 + 16 + 3 + 4}{456} \cdot \frac{2}{3}.$$

Let us now consider CS-1.¹ For the block coding a systematic fire code is used. There is no pre-coding of the USF bits. The convolutional coding is done with the known rate-1/2 encoder, however, no puncturing is applied. Using CS-4, the three USF bits are mapped to 12 bits. No convolutional coding is applied.

For the coding of the traffic channel (PDTCH), one of the four coding schemes is chosen, depending on the quality of the channel. Under very bad channel conditions, we may use CS-1 and obtain a data rate of 9.05 kbit/s per GSM time slot, but a very reliable coding. Under good channel conditions, we transmit without convolutional coding and achieve a data rate of 21.4 kbit/s per time slot. With eight time slots, we obtain a maximum data rate of 171.2 kbit/s. In practice, multiple users share the time slots, and thus, a much lower bit rate is available to the individual user. For example, approximately 40 kbit/s per user will be achieved, if three users share the time slots and CS-3 is employed. CS-1 is used for the coding of the signaling channels.²

After encoding, the codewords are input into a block interleaver of depth 4. On the receiver side, the codewords are de-interleaved. The decoding is performed using the well known Viterbi Algorithm (see, e.g., [15]).

PROTOCOL ARCHITECTURE

TRANSMISSION PLANE

Fig. 13 illustrates the protocol architecture of the GPRS transmission plane [11], providing transmission of user data and its associated signaling, e.g., for flow control, error detection, and error correction.

GPRS Backbone: SGSN – GGSN – As mentioned earlier, user data packets are encapsulated within the GPRS backbone network. The GPRS Tunneling Protocol (GTP) [16] tunnels the user data packets and related signaling information between the GPRS support nodes (GSNs). The protocol is defined both between GSNs within one PLMN (Gn interface) and between GSNs of different PLMNs (Gp interface). In the transmission plane, GTP employs a tunnel mechanism to

¹ CS-1 is equivalent to the coding of the GSM SACCH (see [5]).

² For the PRACH a different coding is used.

transfer user data packets. In the signaling plane, GTP specifies a tunnel control and management protocol. The signaling is used to create, modify, and delete tunnels.

GTP packets carry the user's IP or X.25 packets. Below GTP, the standard protocols TCP or UDP are employed to transport the GTP packets within the backbone network. X.25 expects a reliable data link, thus TCP is used. UDP is used for access to IP-based packet data networks, which do not expect reliability in the network layer or below. IP is employed in the network layer to route packets through the backbone. Ethernet, ISDN, or ATM-based protocols may be used below IP.

To summarize, in the GPRS backbone we have an IP/X.25-over-GTP-over-UDP/TCP-over-IP transport architecture.

Subnetwork Dependent Convergence Protocol – The Subnetwork Dependent Convergence Protocol (SNDCP) [17] is used to transfer data packets between SGSN and MS. Its functionality includes:

- Multiplexing of several connections of the network layer onto one virtual logical connection of the underlying LLC layer.
- Compression and decompression of user data and redundant header information.

Air Interface – In the following, we consider the data link layer and the physical layer at the air interface Um.

Data Link Layer: The data link layer between the MS and the network is divided into two sublayers: the LLC layer (between MS-SGSN) and the RLC/MAC layer (between MS-BSS).



■ FIGURE 11. Encoding of GPRS data packets.

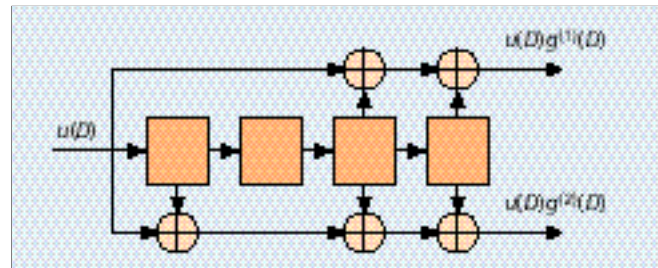

■ FIGURE 12. Convolutional encoder.

The logical link control (LLC) layer [18] provides a highly reliable logical link between an MS and its assigned SGSN. Its functionality is based on the well known HDLC protocol and includes sequence control, in-order delivery, flow control, detection of transmission errors, and retransmission (automatic repeat request (ARQ)). The data confidentiality is ensured by ciphering functions. Variable frame lengths are possible. Both acknowledged and unacknowledged data transmission modes are supported. The protocol is mainly an adapted version of the LAPDm protocol used in GSM (see [5]).

The RLC/MAC layer [19] at the air interface includes two functions. The main purpose of the radio link control (RLC)

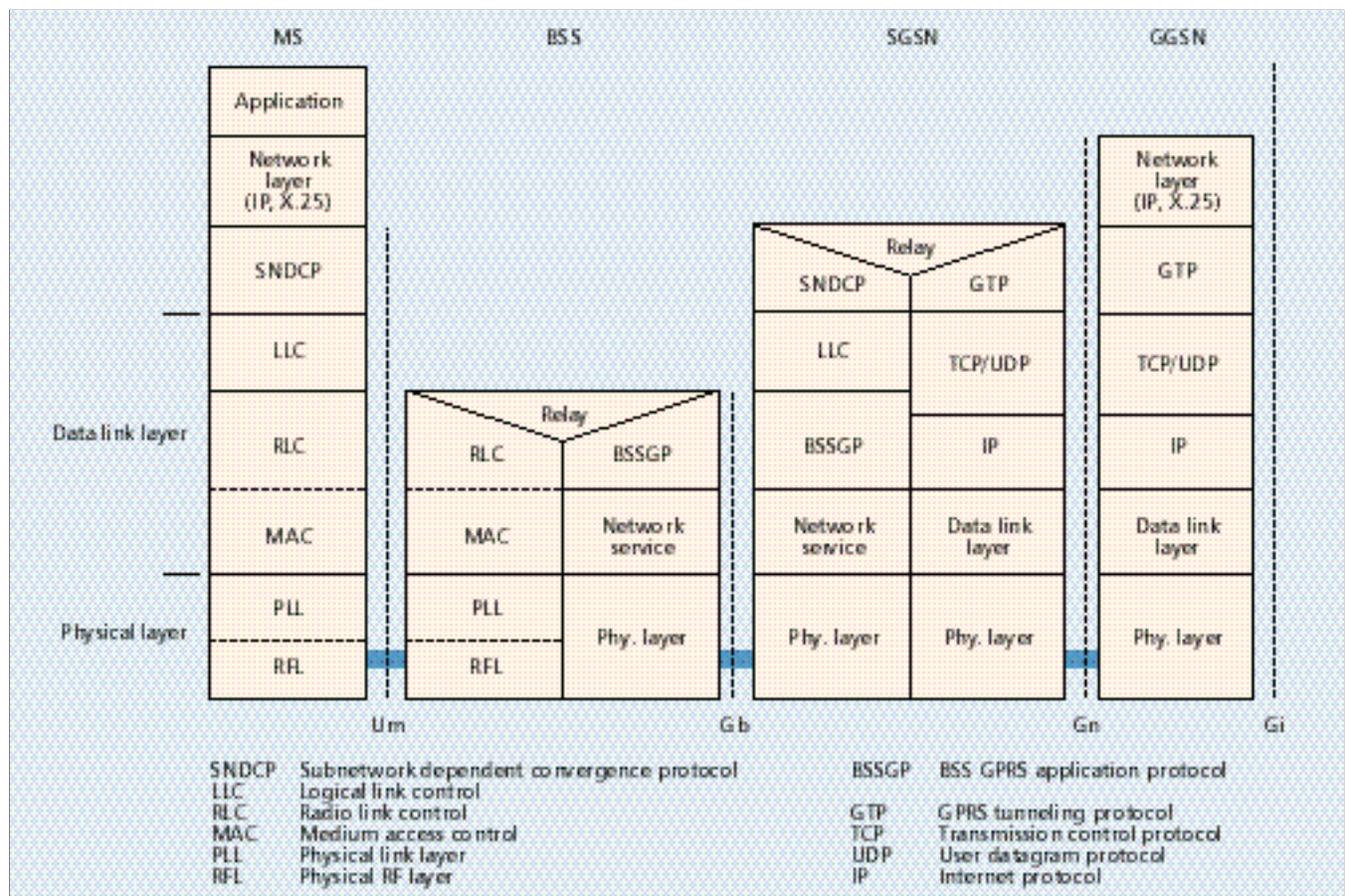

■ FIGURE 13. Transmission plane.

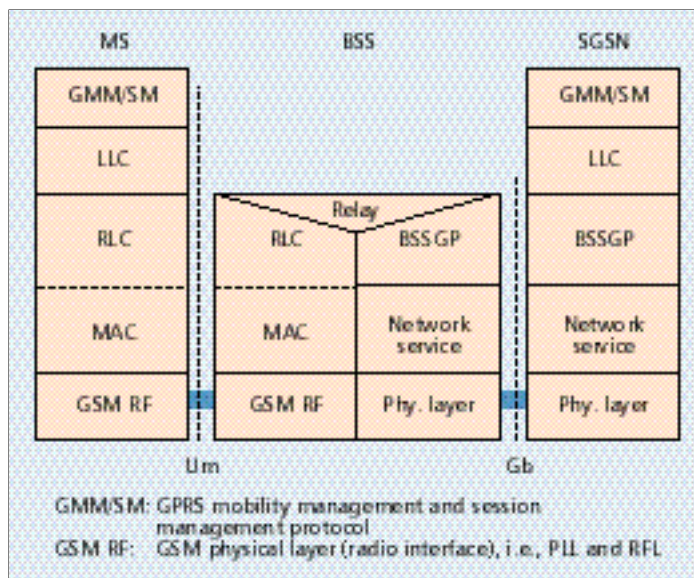

■ FIGURE 14. Signaling plane: MS-SGSN.

layer is to establish a reliable link between the MS and the BSS. This includes the segmentation and reassembly of LLC frames into RLC data blocks and ARQ of uncorrectable codewords. The medium access control (MAC) layer controls the access attempts of an MS on the radio channel shared by several MSs. It employs algorithms for contention resolution, multiuser multiplexing on a PDTCH, and scheduling and prioritizing based on the negotiated QoS. The GPRS MAC protocol is based on the principle of slotted Aloha [20]. In the RLC/MAC layer, both the acknowledged and unacknowledged modes of operation are supported.

Physical Layer: The physical layer between MS and BSS is divided into the two sublayers: the physical link layer (PLL) and the physical RF Layer (RFL).

The PLL provides a physical channel between the MS and the BSS. Its tasks include channel coding (detection of trans-

mission errors, forward error correction (FEC), indication of uncorrectable codewords), interleaving, and detection of physical link congestion.

The RFL operates below the PLL. Among other things, it includes modulation and demodulation.

BSS – SGSN Interface – The BSS GPRS Application Protocol (BSSGP) delivers routing and QoS-related information between BSS and SGSN. The underlying Network Service (NS) protocol is based on the Frame Relay protocol.

SIGNALING PLANE

The protocol architecture of the signaling plane [11] comprises protocols for control and support of the functions of the transmission plane, e.g., GPRS attach and detach, PDP context activation, control of routing paths, and allocation of network resources.

Between MS and SGSN (Fig. 14), the GPRS Mobility Management and Session Management (GMM/SM) protocol supports mobility and session management when performing functions such as GPRS attach/detach, security functions, PDP context activation, and routing area updates.

The signaling architecture between SGSN and the registers HLR, VLR, and EIR (Fig. 15, Fig. 16) uses the same protocols as conventional GSM [5] and extends them with GPRS-specific functionality. Between SGSN and HLR as well as between SGSN and EIR, an enhanced Mobile Application Part (MAP) is employed. The MAP is a mobile network-specific extension of the Signaling System SS#7. It transports the signaling information related to location updates, routing information, user profiles, and handovers. The exchange of MAP messages is accomplished over the transaction capabilities application part (TCAP) and the signaling connection control part (SCCP). The base station system application part (BSSAP+) includes functions of GSM's BSSAP. It is applied to transfer signaling information between the SGSN and the VLR (Gs interface). This includes signaling of the mobility management when coordination of GPRS and conventional GSM functions is necessary (e.g., combined GPRS and non-GPRS location update, combined GPRS/IMSI attach, or paging of an MS via GPRS for an incoming GSM call).

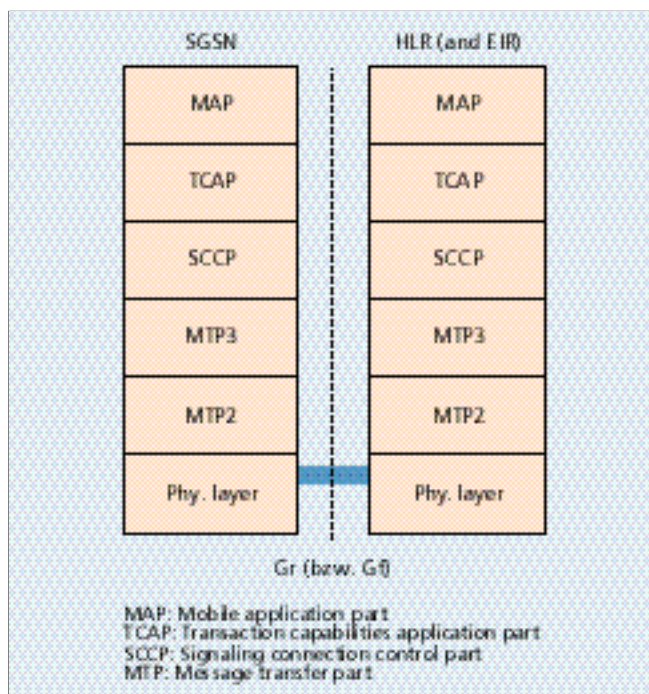

■ FIGURE 15. Signaling plane: SGSN-HLR, SGSN-EIR.

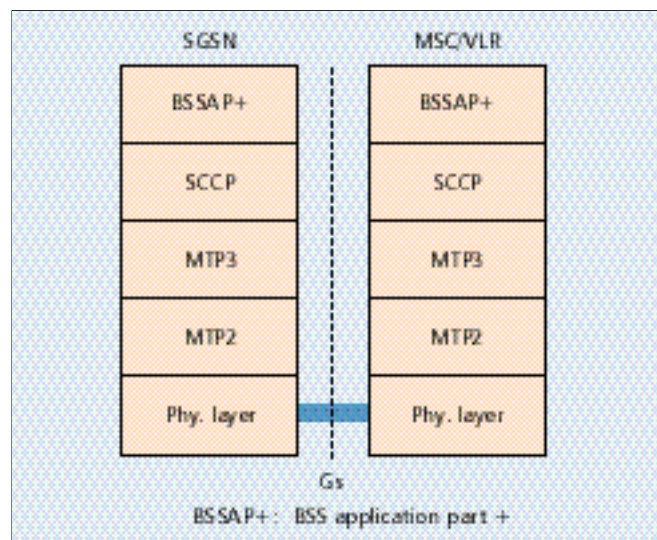

■ FIGURE 16. Signaling plane: SGSN- MSC/VLR.

INTERWORKING WITH IP NETWORKS

Finally, we show how a GPRS network can be interconnected with an IP-based packet data network, such as the Internet or intranets. GPRS supports both IPv4 and IPv6. As shown in Fig. 3, the Gi interface is the interworking point with IP networks. From outside, i.e., from an external IP network's point of view, the GPRS network looks like any other IP sub-network, and the GGSN looks like a usual IP router. Fig. 17 shows the protocol stacks at the GGSN [21].

Fig. 18 gives an example of how a GPRS network may be connected to the Internet. Each registered user who wants to exchange data packets with the IP network gets an IP address, as explained earlier. The IP address is taken from the address space of the GPRS operator. In order to support a large number of mobile users, it is essential to use dynamic IP address allocation (in IPv4). Thus, a DHCP server (Dynamic Host Configuration Protocol [22]) is installed. The address resolution between IP address and GSM address is performed by the GGSN, using the appropriate PDP context. The routing of IP packets and the tunneling through the intra-PLMN backbone (using the GPRS Tunneling Protocol GTP) has been explained in prior sections.

Moreover, a domain name server (DNS) [23] managed by the GPRS operator or the external IP network operator can be used to map between external IP addresses and host names. To protect the PLMN from unauthorized access, a firewall is installed between the private GPRS network and the external IP network.

With this configuration, GPRS can be seen as a wireless extension of the Internet all the way to a mobile station or mobile computer. The mobile user has direct connection to the Internet.

SUMMARY

The General Packet Radio Service GPRS is an important step in the evolution toward third-generation mobile networks. Its packet switched transmission technology is opti-

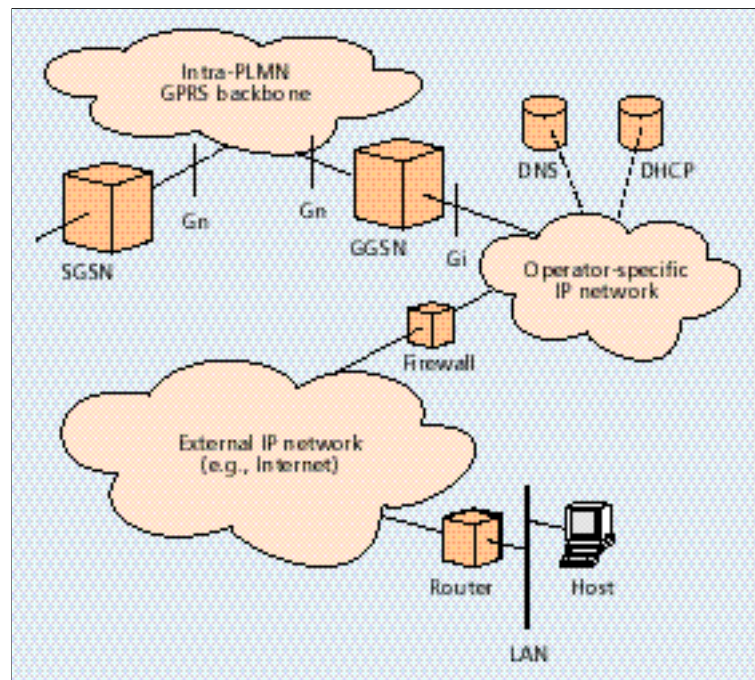

■ FIGURE 18. Example of a GPRS-Internet connection.

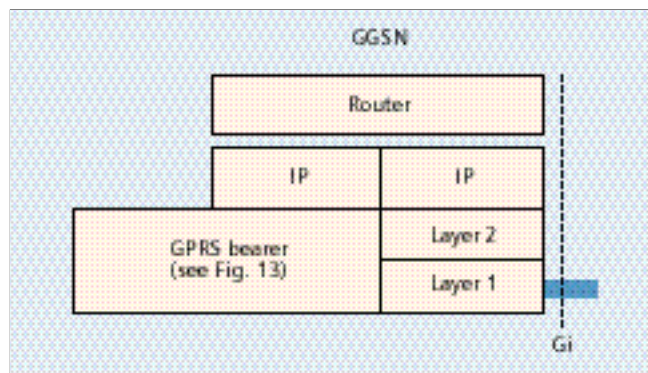

■ FIGURE 17. Protocols at the Gi IP interface.

mized for bursty traffic such as Internet/intranet services. One of the main benefits for users is that they can always be online and may be charged for service based on the amount of transmitted data.

In this paper, we presented an overview of the complex GPRS system.

We discussed the GPRS system architecture with its two new network nodes, namely, the SGSN and GGSN. We explained their functionality and interworking with existing network nodes and data bases (HLR, VLR, EIR). The GSM data bases must be extended with entries for GPRS-specific data.

In its current version, GPRS offers point-to-point bearer services and transport of SMS messages; in future releases point-to-multipoint services will also be offered. An important feature of GPRS is its QoS support. It allows specifying QoS profiles with parameters: service precedence, reliability, delay, and throughput. An individual QoS profile can be negotiated for each PDP context. For the simultaneous usage of conventional GSM and packet switched GPRS services, three classes of mobile stations are defined.

Before a GPRS mobile station can use GPRS services it must obtain an address used in the packet data network (a PDP address) and create a PDP context. The context describes the characteristics of the connection to the packet data network (PDP type, PDP address, QoS, and GGSN). With an active PDP context, packets from the external packet data network will be routed to the GGSN, which then tunnels them to the current SGSN of the mobile user. The GPRS location management is based on the definition of a MS state model. Depending on the state of the MS, it performs many or only few location updates. For this purpose, special routing areas are defined, which are sub-areas of the location areas defined in GSM. Although GPRS has its own mobility management, it cooperates with the GSM mobility management. This results in a more efficient paging mechanism for mobile stations that use GSM and GPRS simultaneously. Dynamic PDP address allocation (e.g., using DHCP) is another important feature, which enables the GPRS provider to support a large number of subscribers.

We also discussed the GPRS air interface. An important concept in GPRS is its multislot capability: from one to eight time slots per TDMA frame can be allocated for a single user. Uplink and downlink are allocated separately. Moreover, the physical channels are only allocated when data packets are sent or received, and they will be released after the transmission of the packets. These features result in an efficient usage of the radio resources. The available radio resources in a cell are shared dynamically between circuit switched (GSM) and packet switched (GPRS) services following a capacity-on-demand

principle. On top of the physical channels, a number of new logical packet channels have been standardized for GPRS. The traffic channel PDTCH is used for payload transmission. One broadcast control channel (PBCCH), four common control channels (PRACH, PAGCH, PPCH, and PNCH), and two dedicated control channels (PACCH and PTCCH) transfer signaling information, e.g., for access control and broadcast of system information. Once again, the coordination between GPRS channels and GSM channels saves radio resources.

GPRS channel coding defines four different coding schemes. Depending on the current radio channel quality, one of them can be chosen to achieve either a high bit rate or strong error protection.

We also showed the protocol architecture of the transmission and signaling plane. GPRS-specific protocols include the GPRS Tunneling Protocol, the GPRS Mobility Management and Session Management protocol, and the BSS GPRS Application Protocol. Some GSM protocols, such as the Mobile Application Part, have been extended.

Finally, a simple GPRS-IP interworking scenario concluded this tutorial.

ACKNOWLEDGEMENTS

The authors would like to thank the anonymous reviewers and their colleagues Christian Hartmann and Anton Riedl for their valuable comments.

REFERENCES

- [1] S. Faccin, Liangchi Hsu, R. Koodli, Khiem Le, and R. Purnadi, GPRS and IS-136 Integration for Flexible Network and Services Evolution, *IEEE Personal Communications*, vol. 6, no. 3, pp. 48-54, June 1999.
- [2] Press release, Neue Wege in der mobilen Datenkommunikation: T-Mobil führt General Packet Radio Service (GPRS) ein, Hannover/Bonn, Germany: T-Mobil (<http://www.t-mobil.de>), March 19, 1999.
- [3] Press release, Hochgeschwindigkeit für das D2-Netz: Mit GPRS blitzschnell auf die Datenautobahn, Düsseldorf, Germany: Mannesmann Mobilfunk GmbH (<http://www.d2mannesmann.de>), August 9, 1999.
- [4] M. Rahnema, "Overview of the GSM System and Protocol Architecture," *IEEE Communications*, vol. 31, no. 4, pp. 92-100, April 1993.
- [5] J. Eberspächer and H.-J. Vögel, *GSM: Switching, Services and Protocols*, John Wiley & Sons, 1998.
- [6] G. Heine, *GSM Networks: Protocols, Terminology, and Implementation*, Artech House, 1999.
- [7] M. Mouly and M.-B. Pautet, *The GSM System for Mobile Communications*, Telecom Pub, 1992.
- [8] GSM 03.02, Network architecture.
- [9] GSM 02.60, GPRS, Service description, Stage 1.
- [10] G. Brasche and B. Walke, Concepts, Services, and Protocols of the New GSM Phase 2+ General Packet Radio Service, *IEEE Communications*, vol. 35, no. 8, pp. 94-104, August 1997.
- [11] GSM 03.60, GPRS, Service description, Stage 2.
- [12] GSM 03.64, GPRS, Overall description of the GPRS radio interface, Stage 2.
- [13] GSM 05.02, Multiplexing and multiple access on the radio path.
- [14] GSM 05.03, Channel coding.
- [15] R. Johannesson and K. Sh. Zigangirov, *Fundamentals of Convolutional Codes*, IEEE Press, 1999.
- [16] GSM 09.60, GPRS, GPRS Tunneling Protocol (GTP) across the Gn and Gp interface.
- [17] GSM 04.65, GPRS, MS-SGSN, Subnetwork Dependent Convergence Protocol (SNDCP).
- [18] GSM 04.64, GPRS, MS-SGSN, Logical Link Control (LLC) layer.
- [19] GSM 04.60, GPRS, MS-BSS interface, Radio Link Control / Medium Access Control (RLC/MAC) protocol.
- [20] D. Bertsekas and R. Gallager, *Data Networks*, Englewood Cliffs, Prentice Hall, 1987.
- [21] GSM 09.61, GPRS, Interworking between the PLMN supporting GPRS and Packet Data Networks (PDN).
- [22] R. Droms, Automated Configuration of TCP/IP with DHCP, *IEEE Internet Computing*, vol. 3, no. 4, pp. 45-53, July/August 1999.
- [23] P. V. Mockapetris, *Domain Names: Concepts and Facilities*, RFC 1034, 1987.
- [24] J. Cai and D. J. Goodman, General Packet Radio Service in GSM, *IEEE Communications*, vol. 35, no. 10, pp. 122-131, October 1997.
- [25] H. Granbohm and J. Wiklund, GPRS: General Packet Radio Service, *Ericsson Review*, vol. 76, no. 2, pp. 82-88, 1999.

ADDITIONAL READING

- [24] J. Cai and D. J. Goodman, General Packet Radio Service in GSM, *IEEE Communications*, vol. 35, no. 10, pp. 122-131, October 1997.
- [25] H. Granbohm and J. Wiklund, GPRS: General Packet Radio Service, *Ericsson Review*, vol. 76, no. 2, pp. 82-88, 1999.

BIOGRAPHIES

CHRISTIAN BETTSTETTER (Christian.Bettstetter@ei.tum.de) studied electrical engineering and information technology at the Munich University of Technology (TUM), Germany, from 1993 until 1998. He received the Dipl.-Ing. degree in 1998. In 1998 he spent a research semester at the University of Notre Dame, Indiana, USA, working on his thesis in the field of turbo decoding and tail-biting. Since August 1998, Mr. Bettstetter has been a member of the research and teaching staff at the Institute of Communication Networks at TUM, where he is working toward his PhD/Dr.-Ing. degree. His current interests are in the area of mobile communication networks, especially in the field of mobility concepts and management, ad-hoc networking, and mobile IP. He is a student member of the IEEE, ACM, and the German VDE/ITG.

HANS-JÖRG VÖGEL received the Dipl.-Ing. degree in electrical engineering and information technology from the Munich University of Technology (TUM) in 1993. After graduating, he joined the Institute of Communication Networks at TUM, where he is currently pursuing his doctoral degree. His research interests are in the area of 2nd and 3rd generation mobile communication networks, mobile network architectures, and signaling protocols. His current work and PhD project focuses on handover and routing mechanisms in mobile ATM networks. Mr. Vögel has authored the textbook "GSM: Switching, Services and Protocols" (Wiley, 1998). He is a student member of the IEEE and a member of Corps Vitruvia.

JÖRG EBERSPÄCHER studied electrical engineering at the University of Stuttgart, Germany, where he earned the Dipl.-Ing. and Dr.-Ing. degrees in 1970 and 1976, respectively. From 1970 to 1977 he was member of the research staff at the Institute of Electrical Communications, University of Stuttgart. From 1977 to 1990 he was with Siemens AG, Munich, Germany, where he was responsible, in various positions, for research and development in the fields of high-speed networks (LAN, ATM) and intelligent networks. For many years he was an active contributor to international standardization bodies, e.g., ANSI and ECMA. Since 1990, Dr. Eberspächer has been a full professor and head of the Institute of Communication Networks at the Munich University of Technology. He is author of the book "GSM: Switching, Services and Protocols" (Wiley, 1998), editor of several books on advanced topics in telecommunications, and has been serving as a member of the program committees of many international conferences. He is also a guest professor at the Tongji University in Shanghai, China. Dr. Eberspächer is a senior member of IEEE and member of ACM and VDE. He is chairman of the German Information Technology Society (VDE/ITG), chairman of the scientific board of the Heinrich-Hertz-Institut (HHI) Berlin, and a member of the board of the Münchner Kreis.